



TEMPERATURE CONTROL
FOR **TODAY & TOMORROW**

MITSUBISHI
HEAVY INDUSTRIES

FDC1200KXZE2

Capacitate nominala de racire: **120.0 KW**



Specificatii

Combinatii posibile (FDC)			400KXZE2 + 400KXZE2 + 400KXZE2
Capacitate nominala (cai putere)			42HP
Sursă de alimentare			Trifazic 380-415V, 50Hz
Putere de pornire		A	15
Curent maxim admis		A	96.0
Capacitate nominala	Racire	kW	120.0
	Incalzire		135.0
Consumul de energie	Racire	kW	32.94
	Incalzire		32.68
Dimensiuni exterioare	I/L/A	mm	2052x4050x720
Greutate netă		kg	996
Refrigerant	Tip / GWP		R410A
Incarcare refrigerant	R410A	kg	11.5x3



TEMPERATURE CONTROL FOR TODAY & TOMORROW



Dimensiuni țevă refrigerant	Refrigerant lichid	mm(in)	ø19.05(3/4")
Dimensiuni țevă refrigerant	Refrigerant gazos	mm(in)	ø38.1(1 1/2") [ø34.92(1 3/8")]
Capacitatea minima/maxima acceptata		%	50~130
Numarul maxim de unitati interne acceptate			80

Schema tehnica

Dimensions

All measurements in mm.

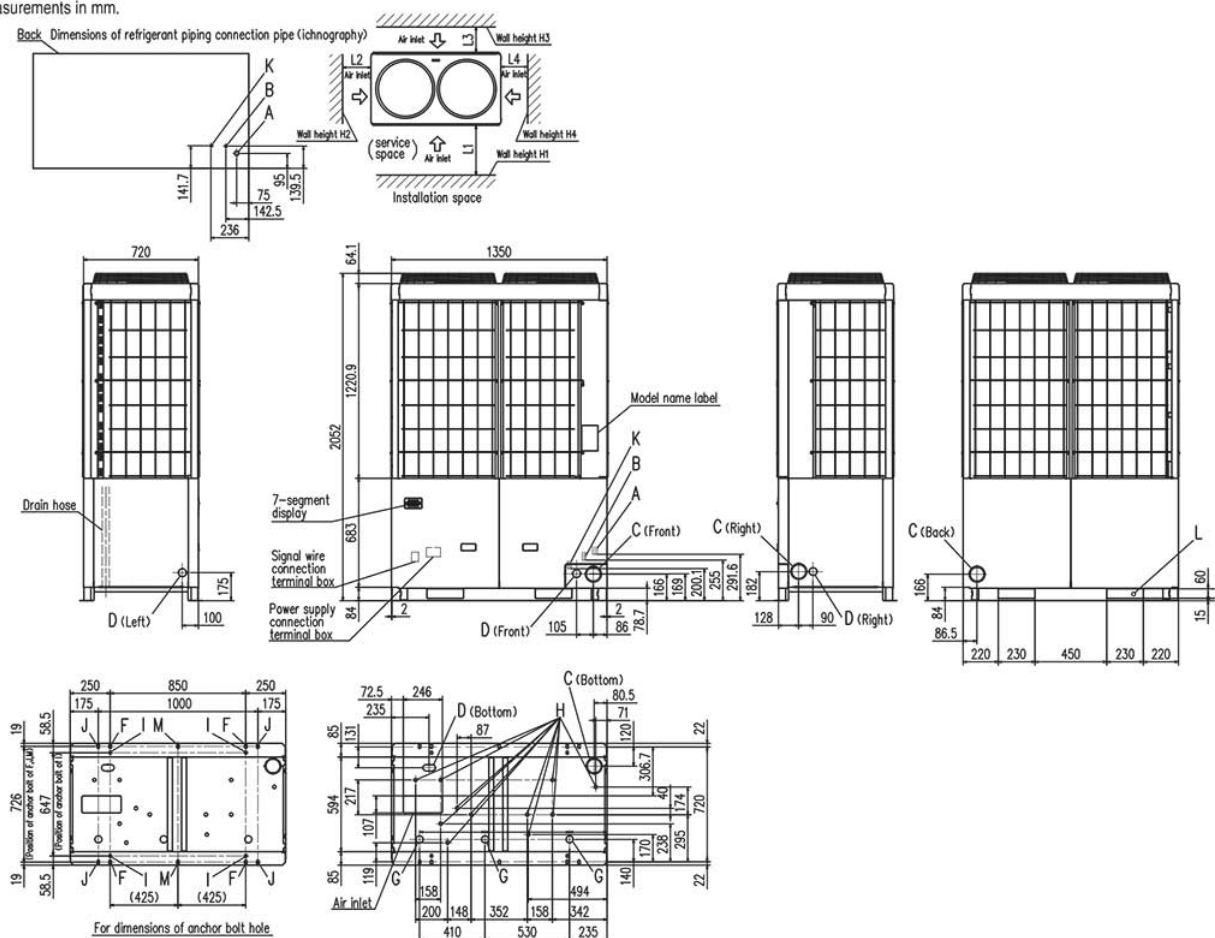

Datorită politicii de continuă îmbunătățire a produselor, ne rezervăm dreptul de a modifica specificațiile tehnice fără nicio notificare prealabilă.