



TEMPERATURE CONTROL  
FOR TODAY & TOMORROW

  
**mitsubishi**  
**HEAVY INDUSTRIES**

## FDC1620KXZRE2

Capacitate nominala de racire: **162.0 KW**



## Specificatii

Combinatii posibile (FDC)			500KXZRE2 + 560KXZRE2 + 560KXZRE2
Capacitate nominala (cai putere)			58HP
Sursă de alimentare			Trifazic 380-415V, 50Hz
Putere de pornire		A	24
Curent maxim admis		A	124.2
Capacitate nominala	Racire	kW	162.0
	Incalzire		162.0
Consumul de energie	Racire	kW	53.82
	Incalzire		42.55
Dimensiuni exterioare	I/L/A	mm	2052x4050x720
Greutate netă		kg	1260
Refrigerant	Tip / GWP		R410A
Incarcare refrigerant	R410A	kg	11.5x3



## TEMPERATURE CONTROL FOR TODAY & TOMORROW



Dimensiuni țevă refrigerant	Refrigerant lichid	mm(in)	ø19.05(3/4")
Dimensiuni țevă refrigerant	Admisie refrigerant gazos	mm(in)	ø38.1(1 1/2") [ø34.92(1 3/8")]
Dimensiuni țevă refrigerant	Refulare refrigerant gazos	mm(in)	ø31.75(1 1/4") [ø28.58(1 1/8")]
Capacitatea minima/maxima acceptata		%	50~130
Numarul maxim de unitati interne acceptate			80

## Schema tehnica

---

**Datorită politicii de continuă îmbunătățire a produselor, ne rezervăm dreptul de a modifica specificațiile tehnice fără nicio notificare prealabilă.**



# TEMPERATURE CONTROL FOR TODAY & TOMORROW



## Dimensions

All measurements in mm.

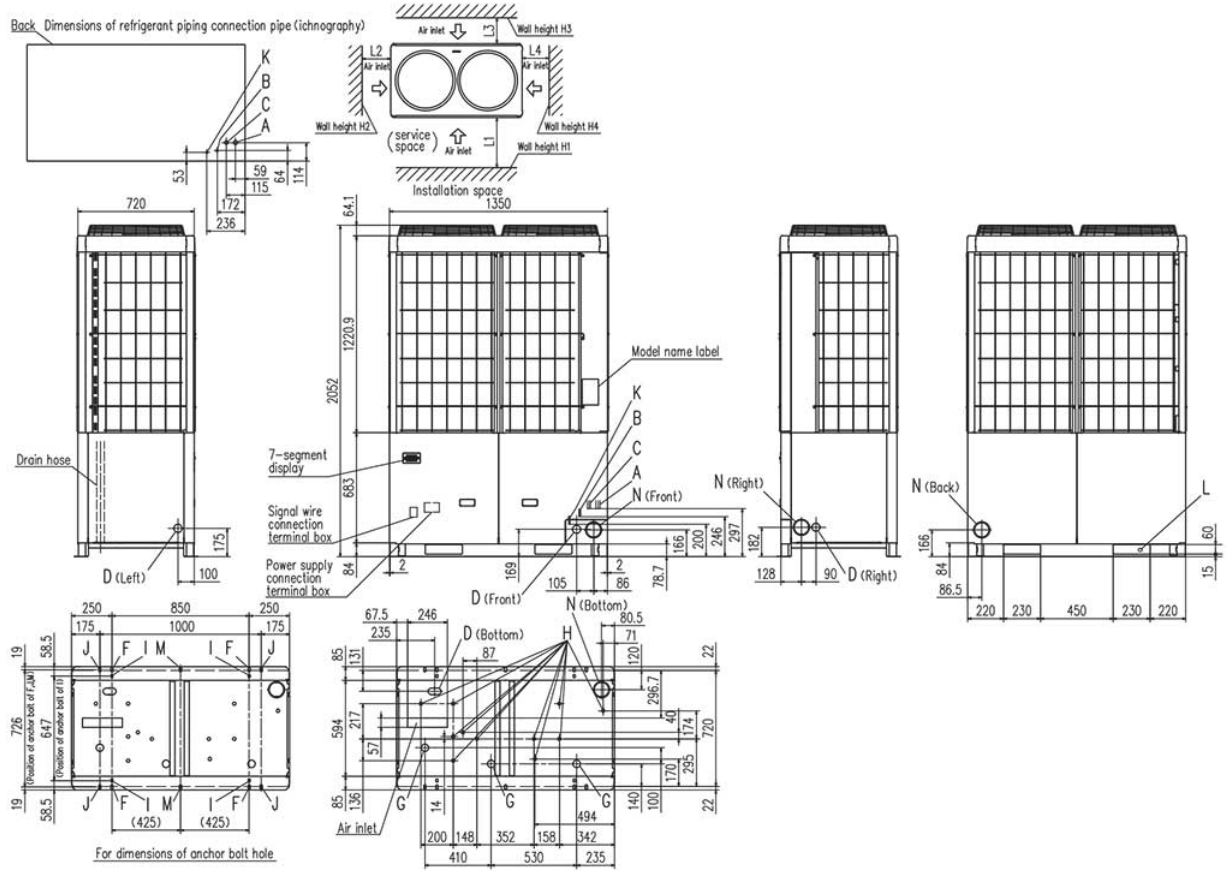

**Datorită politicii de continuă îmbunătățire a produselor, ne rezervăm dreptul de a modifica specificațiile tehnice fără nicio notificare prealabilă.**