



TEMPERATURE CONTROL
FOR **TODAY & TOMORROW**

MITSUBISHI
HEAVY INDUSTRIES

FDC560KXZRE2

Capacitate nominala de racire: **56.0 KW**



Specificatii

Capacitate nominala (cai putere)			20HP
Sursă de alimentare			Trifazic 380-415V, 50Hz
Putere de pornire		A	8
Curent maxim admis		A	41.6
Capacitate nominala	Racire	kW	56.0
	Incalzire		56.0
Consumul de energie	Racire	kW	19.31
	Incalzire		14.93
Dimensiuni exterioare	I/L/A	mm	2052x1350x720
Nivel de presiune sonoră	Racire/Incalzire	dB(A)	64/63
Greutate netă		kg	420
Refrigerant	Tip / GWP		R410A / 2088
Refrigerant	Incarcare	kg/TCO2Eq	11.5 / 24.012



TEMPERATURE CONTROL FOR TODAY & TOMORROW



Dimensiuni țevă refrigerant	Refrigerant lichid	mm(in)	ø12.7(1/2")
Dimensiuni țevă refrigerant	Admisie refrigerant gazos	mm(in)	ø28.58(1 1/8")
Dimensiuni țevă refrigerant	Refulare refrigerant gazos	mm(in)	ø22.22(7/8")
Capacitatea minima/maxima acceptata		%	50~160
Numarul maxim de unitati interne acceptate			59

Schema tehnica

Datorită politicii de continuă îmbunătățire a produselor, ne rezervăm dreptul de a modifica specificațiile tehnice fără nicio notificare prealabilă.



TEMPERATURE CONTROL FOR TODAY & TOMORROW



Dimensions

All measurements in mm.

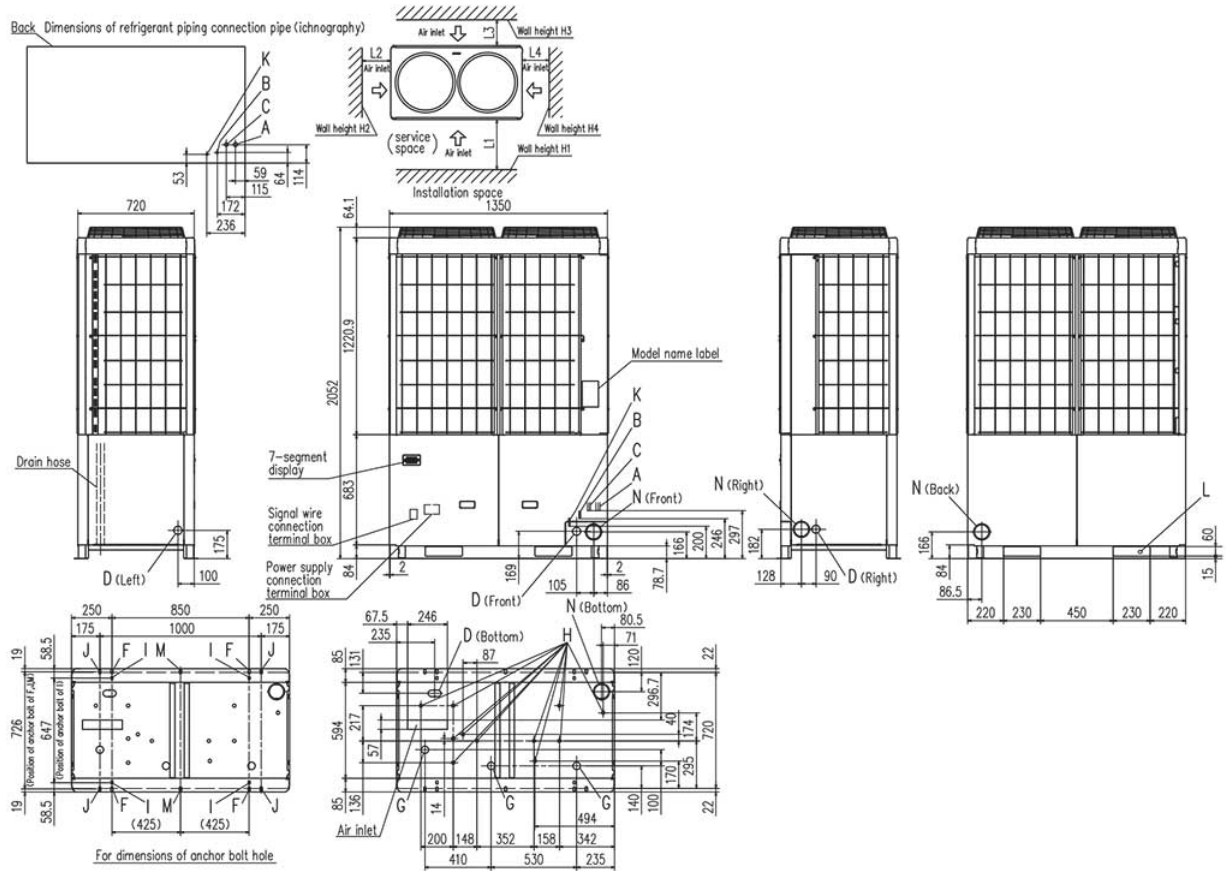

Datorită politicii de continuă îmbunătățire a produselor, ne rezervăm dreptul de a modifica specificațiile tehnice fără nicio notificare prealabilă.