



TEMPERATURE CONTROL
FOR **TODAY & TOMORROW**

MITSUBISHI
HEAVY INDUSTRIES

FDC850KXZE2

Capacitate nominala de racire: **85.0 KW**



Specificatii

Combinatii posibile (FDC)			400KXZE2 + 450KXZE2
Capacitate nominala (cai putere)			30HP
Sursă de alimentare			Trifazic 380-415V, 50Hz
Putere de pornire		A	10
Curent maxim admis		A	64.0
Capacitate nominala	Racire	kW	85.0
	Incalzire		95.0
Consumul de energie	Racire	kW	24.96
	Incalzire		22.73
Dimensiuni exterioare	I/L/A	mm	2052x2700x720
Greutate netă		kg	664
Refrigerant	Tip / GWP		R410A / 2088
Refrigerant	Incarcare	kg/TCO2Eq	11.5x2



TEMPERATURE CONTROL FOR TODAY & TOMORROW



Dimensiuni țevă refrigerant	Refrigerant lichid	mm(in)	ø15.88(5/8")
Dimensiuni țevă refrigerant	Refrigerant gazos	mm(in)	ø31.75(1 1/4") [ø34.92(1 3/8")]
Capacitatea minima/maxima acceptata		%	50~160
Numarul maxim de unitati interne acceptate			80

Schema tehnica

Dimensions

All measurements in mm.

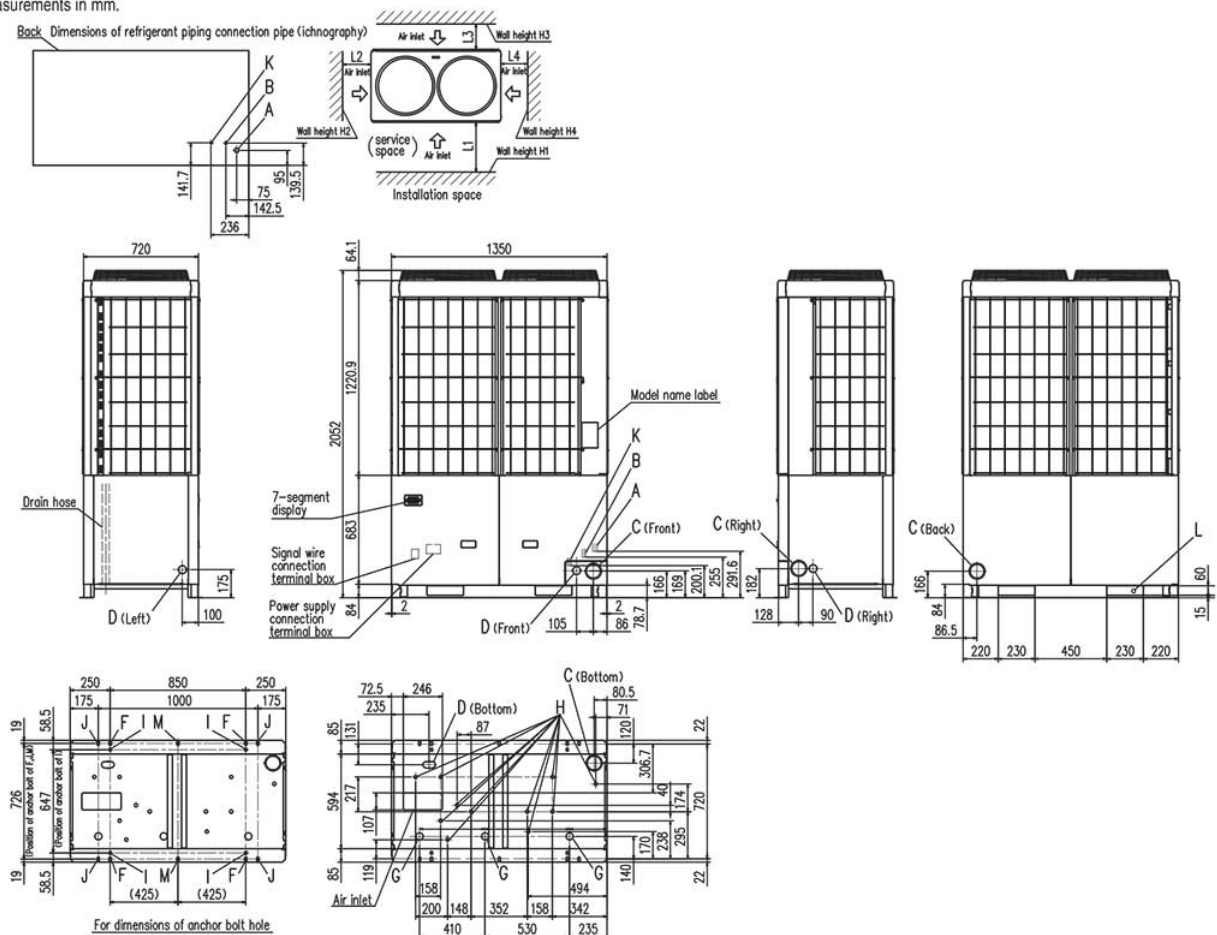

Datorită politicii de continuă îmbunătățire a produselor, ne rezervăm dreptul de a modifica specificațiile tehnice fără nicio notificare prealabilă.