



TEMPERATURE CONTROL
FOR **TODAY & TOMORROW**

mitsubishi
HEAVY INDUSTRIES

FDU71KXE6F

Capacitate nominala de racire: **7.1 KW**



Specificatii

Capacitate nominală de răcire		kW	7.1
Capacitate nominala de incalzire		kW	8.0
Sursă de alimentare			Monofazic 220-240V, 50Hz
Consumul de energie	Racire	kW	0.24-0.25
	Incalzire	kW	0.24-0.25
Nivel putere sonoră		dB(A)	65
Nivel de presiune sonoră racire		db(A)	P-Hi: 38 Hi:33 Me:29 Lo:25
Dimensiuni exterioare unitate	I x L x A	mm	280x950x635
Greutate netă		kg	34
Flux de aer		m3/min	P-Hi: 24 Hi:19 Me:15 Lo:10
Presiunea statica externa maxima		Pa	200
Aport de aer proaspat			Este posibil
Filtru de aer			Intreaba un specialist ATX HVAC



TEMPERATURE CONTROL FOR TODAY & TOMORROW



Telecomanda (opționalal)		Cu fir: RC-EX3A, RC-E5, RCH-E3 Fara fir: RCN-KIT4-E2
Dimensiuni țeavă refrigerant	mm(in)	Refrigerant lichid: $\varnothing 9.52(3/8")$ Refrigerant gazos: $\varnothing 15.88(5/8")$

Schema tehnica

FDU71KXE6F, 90KXE6F

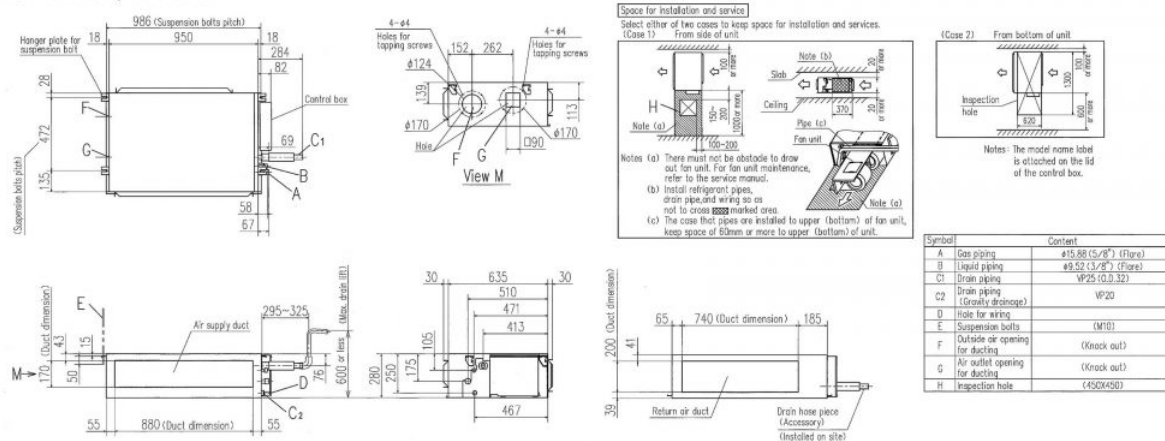

Datorită politicii de continuă îmbunătățire a produselor, ne rezervăm dreptul de a modifica specificațiile tehnice fără nicio notificare prealabilă.