



TEMPERATURE CONTROL
FOR TODAY & TOMORROW

MITSUBISHI
HEAVY INDUSTRIES

SRK25ZS-WF / SRC25ZS-W2

Capacitate nominala de racire: **2.5 KW**



Poze unitate interna si unitate externa



Specificatii

Unitate internă			SRK25ZS-WF
Unitate externă			SRC25ZS-W2
Sursă de alimentare			Monofazic, 220 - 240, 50Hz
Capacitate nominală de răcire (Min~Max)		kW	2.5(0.9~3.1)
Capacitate nominală de încălzire (Min~Max)		kW	3.2(0.9~4.5)
Consum de energie	Răcire/Încălzire	kW	0.62 / 0.74
EER/COP	Răcire/Încălzire		4.03 / 4.32



TEMPERATURE CONTROL FOR TODAY & TOMORROW



Amperaj maxim			A	9
Nivel putere sonoră	U.I.	Răcire/Încălzire	dB(A)	50 / 53
	U.E.	Răcire/Încălzire		56 / 58
Nivel presiune sonoră	U.I.	Răcire (Hi/Me/Lo/Ulo)		36 / 28 / 23 / 19
		Încălzire (Hi/Me/Lo/Ulo)		39 / 30 / 24 / 19
	U.E.	Răcire/Încălzire		46 / 46
Flux de aer	U.I.	Răcire (Hi/Me/Lo/Ulo)	m ³ /min	9.9 / 8.0 / 5.9 / 5.0
		Încălzire (Hi/Me/Lo/Ulo)		11.3 / 8.7 / 6.7 / 5.9
	U.E.	Răcire/Încălzire		27.4 / 23.6
Dimensiuni exterioare	U.I.	Înălțime / Lățime / Adâncime	mm	290 x 870 x 230
	U.E.			540 x 780(+62) x 290
Greutate netă	U.I. / U.E.		kg	9.5 / 31.0
Refrigerant		Tip/GWP		R32 / 675
Refrigerant		Încărcare	kg/TCO ₂ Eq	0.62 / 0.419
Dimensiuni țevă refrigerant		Lichid/Gaz	mm/ø	6.35(1/4") / 9.52(3/8")
Lungime țevă refrigerant (o direcție)			m	Max. 20
Diferență de nivel suportată		Unitate externă este mai sus/mai jos	m	Max. 10 / Max. 10
Interval de funcționare - temperatură exterioară		Răcire	°C	-15 ~ +46

Datorită politicii de continuă îmbunătățire a produselor, ne rezervăm dreptul de a modifica specificațiile tehnice fără nicio notificare prealabilă.



TEMPERATURE CONTROL FOR TODAY & TOMORROW



Încălzire	-15 ~ +24	
Filtre		Filtru Antialergeni x1, Filtru lavabil fotocatalitic și dezodorizant x1
Clasa Energetică (Răcire/Încălzire)		A+++/A++
SEER		8.50
SCOP (Climat temperat)		4.70
Pdesign (răcire/încălzire(@-10°C))	kW	2.50/2.70
Consumul anual de electricitate (răcire/încălzire)	kWh/a	103/804
Performanța pe modul încălzire		Climat temperat

Schema tehnica

Datorită politicii de continuă îmbunătățire a produselor, ne rezervăm dreptul de a modifica specificațiile tehnice fără nicio notificare prealabilă.



TEMPERATURE CONTROL FOR TODAY & TOMORROW



- SRK20ZS-WF, -WFB, -WFT, -W
- SRK25ZS-WF, -WFB, -WFT, -W
- SRK35ZS-WF, -WFB, -WFT, -W
- SRK50ZS-WF, -WFB, -WFT, -W
- SRK20ZS-S, -SB, -ST SRK25ZS-S, -SB, -ST
- SRK35ZS-S, -SB, -ST SRK50ZS-S, -SB, -ST

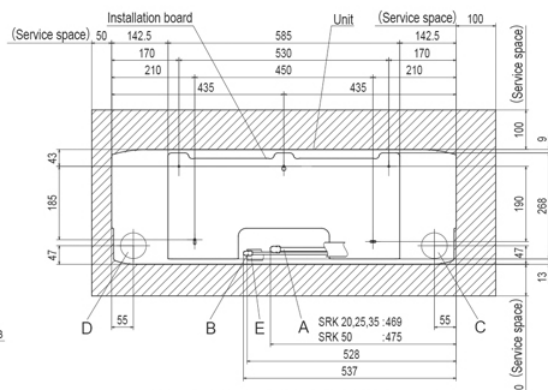
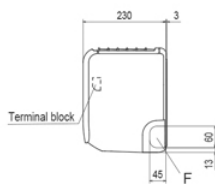
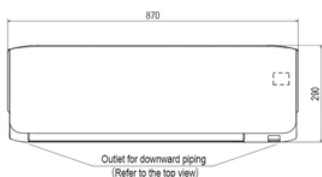

Space for installation and service when viewing from the front

Symbol	Content
A	Gas piping SRK20, 25, 35 $\phi 9.52$ (3/8") (Flare) SRK50 $\phi 12.7$ (1/2") (Flare)
B	Liquid piping $\phi 6.35$ (1/4") (Flare)
C	Hole on wall for right rear piping ($\phi 65$)
D	Hole on wall for left rear piping ($\phi 65$)
E	Drain hose VP16
F	Outlet for piping (on both side)

Outdoor units

- SRC20ZS-W, 25ZS-W, 35ZS-W
- SRC25ZS-W1, 35ZS-W1
- SRC25ZS-W2, 35ZS-W2

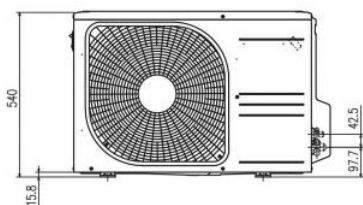
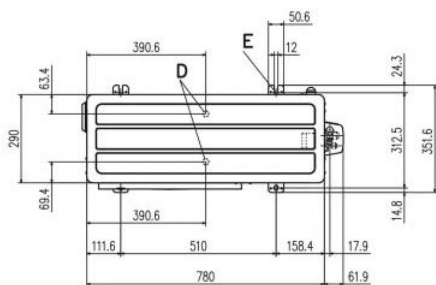

Symbol	Content
A	Service valve connection (gas side) $\phi 9.52$ (3/8") (Flare)
B	Service valve connection (liquid side) $\phi 6.35$ (1/4") (Flare)
C	Pipe/cable draw-out hole
D	Drain discharge hole $\phi 20 \times 2$ places
E	Anchor bolt hole M10 \times 4 places

Dimensions	Minimum installation space			
	I	II	III	IV
L1	Open	280	280	180
L2	100	75	Open	Open
L3	100	80	80	80
L4	250	Open	250	Open

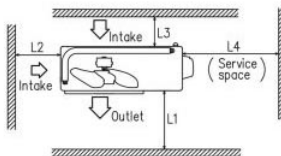
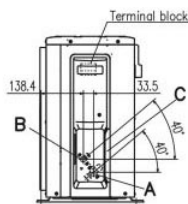

Datorită politicii de continuă îmbunătățire a produselor, ne rezervăm dreptul de a modifica specificațiile tehnice fără nicio notificare prealabilă.