



TEMPERATURE CONTROL
FOR TODAY & TOMORROW

MITSUBISHI
HEAVY INDUSTRIES

SRK35ZSX-WFB

Capacitate nominală de răcire: **3.5 KW**



Specificatii

Capacitate nominală de răcire		kW	3.5
Capacitate nominală de încălzire		kW	4.3
Nivel putere sonoră	Răcire	dB(A)	58
	Încălzire	dB(A)	58
Nivel presiune sonoră	Răcire(Hi/Me/Lo/Ulo)	dB(A)	43 / 35 / 26 / 19
	Încălzire(Hi/Me/Lo/Ulo)	dB(A)	42 / 35 / 28 / 19
Flux de aer	Răcire(Hi/Me/Lo/Ulo)	m ³ /min	13.1 / 10.8 / 7.3 / 5.0
	Încălzire(Hi/Me/Lo/Ulo)	m ³ /min	13.9 / 11.8 / 8.6 / 5.4
Dimensiuni exterioare (HĂ×WĂ×D)		mm	305Ă×920Ă×220
Greutate netă		kg	13.0
Dimensiuni țevă refrigerant	Lichid / Gaz	mm â	6.35(1/4") / 9.52(3/8")
Filtre			Allergen Clear Filter Ă1, Photocatalytic lavabil Deodorizing FilterĂ1



TEMPERATURE CONTROL FOR TODAY & TOMORROW



Schema tehnica

SRK20ZSX-WF, -WFB, -WFT, -W
 SRK25ZSX-WF, -WFB, -WFT, -W
 SRK35ZSX-WF, -WFB, -WFT, -W
 SRK50ZSX-WF, -WFB, -WFT, -W
 SRK60ZSX-WF, -WFB, -WFT, -W
 SRK20ZSX-S SRK25ZSX-S SRK35ZSX-S
 SRK50ZSX-S SRK60ZSX-S

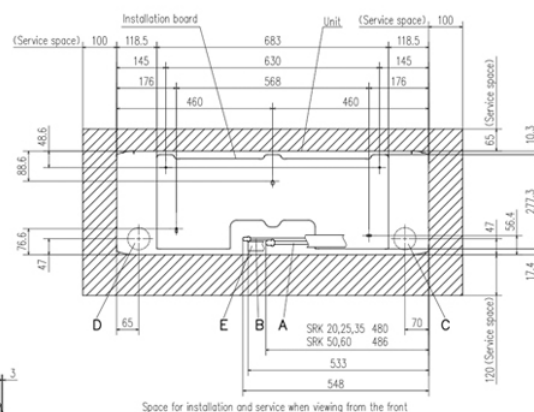
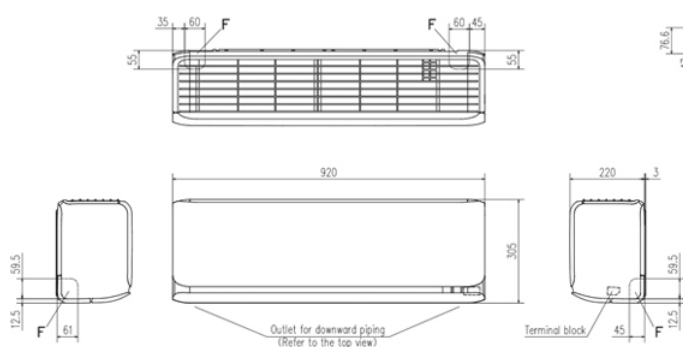

Space for installation and service when viewing from the front

Symbol	Content
A	Gas piping SRK 20,25,35 #9.52 (3/8") (Flare) SRK 50,60 #12.7 (1/2") (Flare)
B	Liquid piping #6.35 (1/4") (Flare)
C	Hole on wall for right rear piping (#55)
D	Hole on wall for left rear piping (#55)
E	Drain hose VP16
F	Outlet for piping

Datorită politicii de continuă îmbunătățire a produselor, ne rezervăm dreptul de a modifica specificațiile tehnice fără nicio notificare prealabilă.