



TEMPERATURE CONTROL
FOR TODAY & TOMORROW

MITSUBISHI
HEAVY INDUSTRIES

SRK50ZS-W / SRC50ZS-W

Capacitate nominala de racire: **5.0 KW**



Poze unitate interna si unitate externa



Specificatii

Unitate internă			SRK50ZS-W
Unitate externă			SRC50ZS-W
Sursă de alimentare			Monofazic, 220 - 240, 50Hz
Capacitate nominală de răcire (Min~Max)		kW	5.0(1.3~5.5)
Capacitate nominală de încălzire (Min~Max)		kW	5.8(1.3~6.6)
Consum de energie	Răcire/Încălzire	kW	1.35 / 1.56
EER/COP	Răcire/Încălzire		3.70 / 3.72



TEMPERATURE CONTROL FOR TODAY & TOMORROW



Amperaj maxim			A	14.5
Nivel putere sonoră	U.I.	Răcire/Încălzire	dB(A)	59 / 60
	U.E.	Răcire/Încălzire		61 / 63
Nivel presiune sonoră	U.I.	Răcire (Hi/Me/Lo/Ulo)		46 / 36 / 29 / 22
		Încălzire (Hi/Me/Lo/Ulo)		46 / 37 / 31 / 24
	U.E.	Răcire/Încălzire		51 / 52
Flux de aer	U.I.	Răcire (Hi/Me/Lo/Ulo)	m ³ /min	12.1 / 9.9 / 7.4 / 5.9
		Încălzire (Hi/Me/Lo/Ulo)		13.9 / 11.2 / 9.1 / 7.4
	U.E.	Răcire/Încălzire		32.8 / 32.8
Dimensiuni exterioare	U.I.	Înălțime / Lățime / Adâncime	mm	290 x 870 x 230
	U.E.			595 x 780(+62) x 290
Greutate netă	U.I. / U.E.		kg	10.0 / 36.0
Refrigerant		Tip/GWP		R32 / 675
Refrigerant		Încărcare		kg/TCO ₂ Eq
Dimensiuni țevă refrigerant		Lichid/Gaz		mm/ø
Lungime țevă refrigerant (o direcție)			m	Max. 25
Diferență de nivel suportată		Unitate externă este mai sus/mai jos		m
Interval de funcționare - temperatură exterioară		Răcire		°C
				-15~46

Datorită politicii de continuă îmbunătățire a produselor, ne rezervăm dreptul de a modifica specificațiile tehnice fără nicio notificare prealabilă.



TEMPERATURE CONTROL FOR TODAY & TOMORROW



Încălzire	-15~24		
Filtre			Filtru Antialergeni x1, Filtru lavabil fotocatalitic și dezodorizant x1
Clasa Energetică (Răcire/Încălzire)			A++/A++
SEER			7.00
SCOP (Climat temperat)			4.60
Pdesign (răcire/încălzire(@-10°C))	kW		5.00/3.80
Consumul anual de electricitate (răcire/încălzire)	kWh/a		250/1158
Performanța pe modul încălzire			Climat temperat

Schema tehnica

Datorită politicii de continuă îmbunătățire a produselor, ne rezervăm dreptul de a modifica specificațiile tehnice fără nicio notificare prealabilă.



TEMPERATURE CONTROL FOR TODAY & TOMORROW



SRC50ZS-W,-S SRC25ZMX-S SRC35ZMX-S SRC45ZSP-W,-S

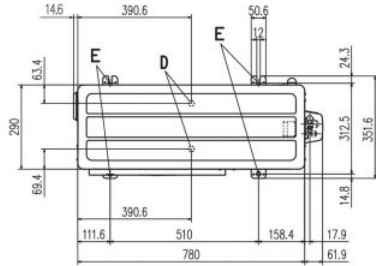

Symbol	Content
A	Service valve connection (gas side) ZMX: $\phi 9.52(3/8)$ (Flare) ZS,ZMP: $\phi 12.7(1/2)$ (Flare)
B	Service valve connection (liquid side) $\phi 6.35(1/4)$ (Flare)
C	Pipe/cable draw-out hole $\phi 20 \times 2$ places
D	Drain discharge hole $\phi 20 \times 2$ places
E	Anchor bolt hole M10 $\times 4$ places

Dimensions	Minimum installation space			
	I	II	III	IV
L1	Open	280	280	180
L2	100	75	Open	Open
L3	100	80	80	80
L4	250	Open	250	Open

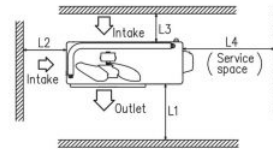
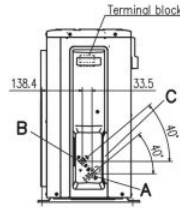
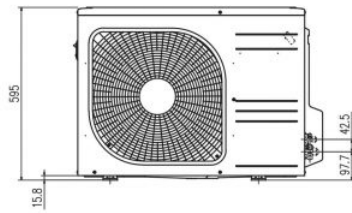

SRK20ZS-W,-WB,-WT SRK25ZS-W,-WB,-WT SRK35ZS-W,-WB,-WT SRK50ZS-W,-WB,-WT SRK20ZS-S,-SB,-ST SRK25ZS-S,-SB,-ST SRK35ZS-S,-SB,-ST SRK50ZS-S,-SB,-ST

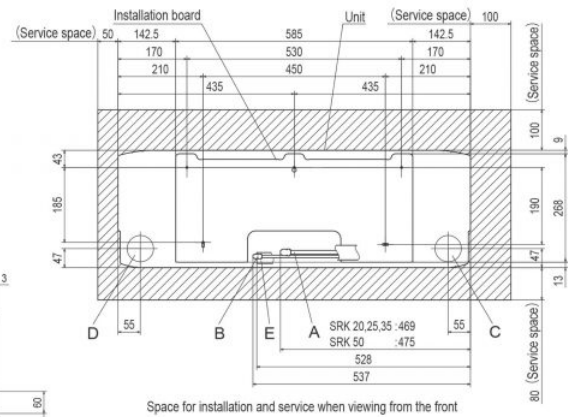
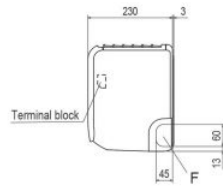
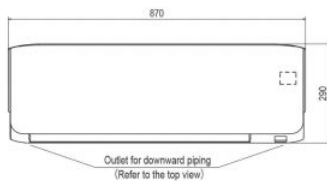

Symbol	Content
A	Gas piping SRK20, 25, 35: $\phi 9.52(3/8)$ (Flare) SRK50: $\phi 12.7(1/2)$ (Flare)
B	Liquid piping $\phi 6.35(1/4)$ (Flare)
C	Hole on wall for right rear piping ($\phi 65$)
D	Hole on wall for left rear piping ($\phi 65$)
E	Drain hose VP16
F	Outlet for piping (on both side)

Datorită politicii de continuă îmbunătățire a produselor, ne rezervăm dreptul de a modifica specificațiile tehnice fără nicio notificare prealabilă.