



TEMPERATURE CONTROL
FOR **TODAY & TOMORROW**

MITSUBISHI
HEAVY INDUSTRIES

SRK71ZTL-W / SRC71ZTL-W

Capacitate nominala de racire: **7.1 KW**

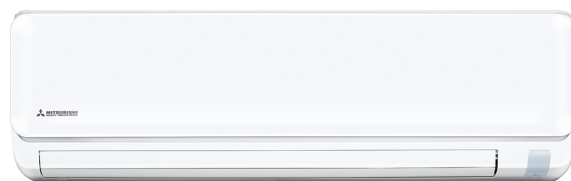

Poze unitate interna si unitate externa

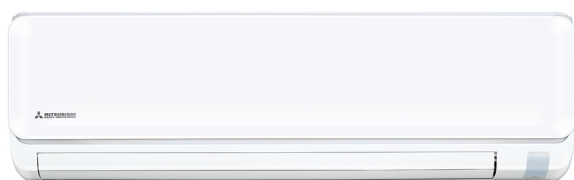

Specificatii

Unitate internă			SRK71ZTL-W
Unitate externă			SRC71ZTL-W
Sursă de alimentare			Monofazic, 220 - 240, 50Hz
Capacitate nominală de răcire (Min~Max)		kW	7.1 (1.2~7.3)
Capacitate nominală de încălzire (Min~Max)		kW	8.0 (1.1~9.1)
Consum de energie	Răcire/Încălzire	kW	2.45 / 2.37
EER/COP	Răcire/Încălzire		2.90 / 3.38



TEMPERATURE CONTROL FOR TODAY & TOMORROW



Amperaj maxim			A	17.0
Nivel putere sonoră	U.I.	Răcire/Încălzire	dB(A)	61 / 61
	U.E.	Răcire/Încălzire		66 / 66
Nivel presiune sonoră	U.I.	Răcire (Hi/Me/Lo/Ulo)		48 / 44 / 39 / 31
		Încălzire (Hi/Me/Lo/Ulo)		47 / 44 / 40 / 33
	U.E.	Răcire/Încălzire		53 / 54
Flux de aer	U.I.	Răcire (Hi/Me/Lo/Ulo)	m ³ /min	17.5 / 15.2 / 12.6 / 9.4
		Încălzire (Hi/Me/Lo/Ulo)		18.9 / 17.7 / 14.6 / 11.6
	U.E.	Răcire/Încălzire		43.0 / 40.9
Dimensiuni exterioare	U.I.	Înălțime / Lățime / Adâncime	mm	294 x 998 x 230
	U.E.			640 x 800(+71) x 290
Greutate netă	U.I. / U.E.		kg	9.5 / 33.0
Refrigerant		Tip/GWP		R32 / 675
Refrigerant		Încărcare		kg/TCO ₂ Eq
Dimensiuni țevă refrigerant		Lichid/Gaz		mm/ø
Lungime țevă refrigerant (o direcție)			m	Max.30
Diferență de nivel suportată		Unitate externă este mai sus/mai jos		m
Interval de funcționare - temperatură exterioară		Răcire		°C
				-15~46

Datorită politicii de continuă îmbunătățire a produselor, ne rezervăm dreptul de a modifica specificațiile tehnice fără nicio notificare prealabilă.



TEMPERATURE CONTROL FOR TODAY & TOMORROW



Încălzire	-15~24	
Filtre		Filtru Antialergeni x1, Filtru lavabil fotocatalitic și dezodorizant x1
Clasa Energetică (Răcire/Încălzire)		A++/A++
SEER		7.10
SCOP (Climat temperat)		4.40
Pdesign (răcire/încălzire(@-10°C))	kW	7.10/6.20
Consumul anual de electricitate (răcire/încălzire)	kWh/a	351/1972
Performanța pe modul încălzire		Climat temperat

Schema tehnica

Datorită politicii de continuă îmbunătățire a produselor, ne rezervăm dreptul de a modifica specificațiile tehnice fără nicio notificare prealabilă.



TEMPERATURE CONTROL FOR TODAY & TOMORROW



SRC20ZSX-W,-S SRC25ZSX-W,-S SRC35ZSX-W,-S SRC40ZSX-W1,-S SRC50ZSX-W2,-S
SRC60ZSX-W1,-S SRC63ZR-W,-S SRC63ZTL-W SRC71ZTL-W

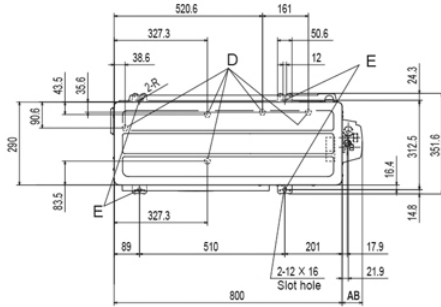

Symbol	Content	
A	Service valve connection (gas side)	20,25,35 ϕ 9.52(3/8") (Flare) 40,50,60,63,71 ϕ 12.7(1/2") (Flare)
B	Service valve connection (liquid side)	ϕ 6.35 (1/4") (Flare)
C	Pipe/cable draw-out hole	
D	Drain discharge hole	ϕ 20X5places
E	Anchor bolt hole	M10-12X4places

Dimensions	Minimum installation space			
	I	II	III	IV
L1	Open	280	280	180
L2	100	75	Open	Open
L3	100	80	80	80
L4	250	Open	250	Open

	AA	AB
ZSX	93	71.2
ZR	94.5	71
ZTL	94.5	71

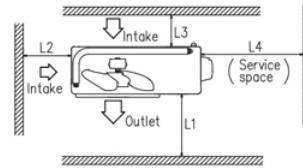
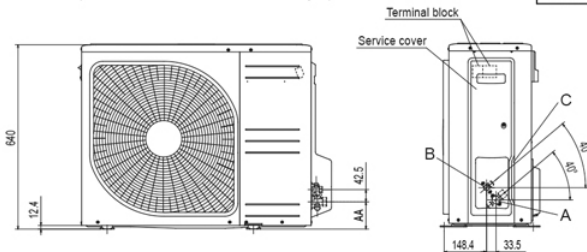

* The ZSX / ZR series does not have fin guard.

SRK63ZTL-W
SRK71ZTL-W

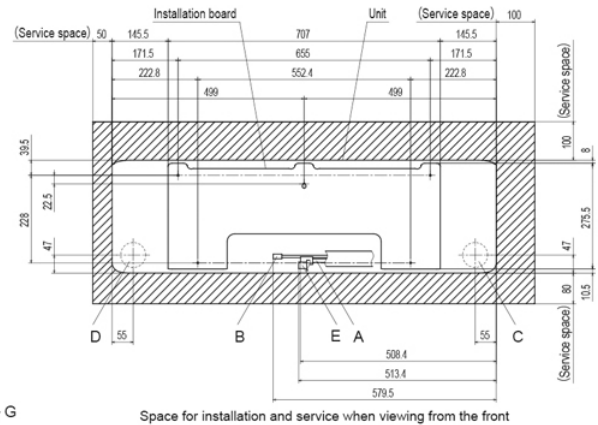
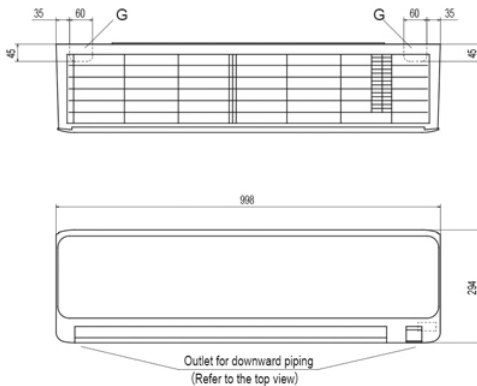

Space for installation and service when viewing from the front

Symbol	Content	
A	Gas piping	ϕ 12.7 (1/2") (Flare)
B	Liquid piping	ϕ 6.35 (1/4") (Flare)
C	Hole on wall for right rear piping	(ϕ 65)
D	Hole on wall for left rear piping	(ϕ 65)
E	Drain hose	VP16
F	Outlet for wiring (on both side)	
G	Outlet for piping (on both side)	

Datorită politicii de continuă îmbunătățire a produselor, ne rezervăm dreptul de a modifica specificațiile tehnice fără nicio notificare prealabilă.