



TEMPERATURE CONTROL
FOR **TODAY & TOMORROW**

MITSUBISHI
HEAVY INDUSTRIES

SRK80ZR-W / SRC80ZR-W

Capacitate nominala de racire: **8.0 KW**



Poze unitate interna si unitate externa



Specificatii

Unitate internă			SRK80ZR-W
Unitate externă			SRC80ZR-W
Sursă de alimentare			Monofazic, 220 - 240, 50Hz
Capacitate nominală de răcire (Min~Max)		kW	8.0 (2.3~9.7)
Capacitate nominală de încălzire (Min~Max)		kW	9.0 (2.1~11.2)
Consum de energie	Răcire/Încălzire	kW	2.09 / 2.27
EER/COP	Răcire/Încălzire		3.83 / 3.96



TEMPERATURE CONTROL FOR TODAY & TOMORROW



Amperaj maxim			A	17
Nivel putere sonoră	U.I.	Răcire/Încălzire	dB(A)	60 / 62
	U.E.	Răcire/Încălzire		67 / 67
Nivel presiune sonoră	U.I.	Răcire (Hi/Me/Lo/Ulo)		47 / 44 / 39 / 26
		Încălzire (Hi/Me/Lo/Ulo)		47 / 41 / 36 / 29
	U.E.	Răcire/Încălzire		56 / 55
Flux de aer	U.I.	Răcire (Hi/Me/Lo/Ulo)	m ³ /min	23.5 / 20.2 / 17.5 / 10.4
		Încălzire (Hi/Me/Lo/Ulo)		26.5 / 21.3 / 18.4 / 13.5
	U.E.	Răcire/Încălzire		63 / 49.5
Dimensiuni exterioare	U.I.	Înălțime / Lățime / Adâncime	mm	339 x 1197 x 262
	U.E.			750 x 880(+88) x 340
Greutate netă	U.I. / U.E.		kg	16.5 / 58.5
Refrigerant		Tip/GWP		R32 / 675
Refrigerant		Încărcare	kg/TCO ₂ Eq	1.6 / 1.080
Dimensiuni țevă refrigerant		Lichid/Gaz	mm/ø	6.35(1/4") / 15.88(5/8")
Lungime țevă refrigerant (o direcție)			m	Max. 30
Diferență de nivel suportată		Unitate externă este mai sus/mai jos	m	Max. 20 / Max. 20
Interval de funcționare - temperatură exterioară		Răcire	°C	-15~46

Datorită politicii de continuă îmbunătățire a produselor, ne rezervăm dreptul de a modifica specificațiile tehnice fără nicio notificare prealabilă.



TEMPERATURE CONTROL FOR TODAY & TOMORROW



Încălzire	-15~24		
Filtre			Filtru Antialergeni x1, Filtru lavabil fotocatalitic și dezodorizant x1
Clasa Energetică (Răcire/Încălzire)			A++/A+
SEER			7.00
SCOP (Climat temperat)			4.40
Pdesign (răcire/încălzire(@-10°C))	kW		8.00/7.10
Consumul anual de electricitate (răcire/încălzire)	kWh/a		401/2259
Performanța pe modul încălzire			Climat temperat

Schema tehnica

Datorită politicii de continuă îmbunătățire a produselor, ne rezervăm dreptul de a modifica specificațiile tehnice fără nicio notificare prealabilă.



TEMPERATURE CONTROL FOR TODAY & TOMORROW



SRC71ZR-W SRC80ZR-W SRC71ZR-S SRC80ZR-S

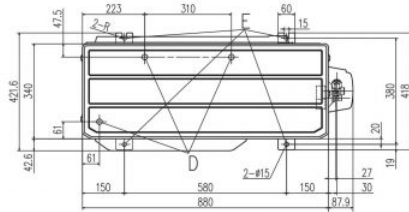

Symbol	Content
A	Service valve connection (gas side) $\phi 15.88$ (5/8") (Flare)
B	Service valve connection (liquid side) $\phi 6.35$ (1/4") (Flare)
C	Pipe/cable draw-out hole
D	Drain discharge hole $\phi 20 \times 3$ places
E	Anchor bolt hole M10 x 4 places

Minimum installation space

Dimensions	Examples of installation		
	I	II	III
L1	Open	Open	500
L2	300	250	Open
L3	100	150	100
L4	250	250	250

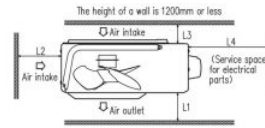
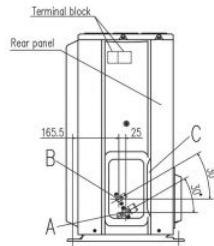
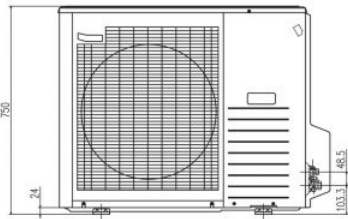

SRK63ZR-W SRK71ZR-W SRK80ZR-W SRK63ZR-S SRK71ZR-S SRK80ZR-S SRK100ZR-S

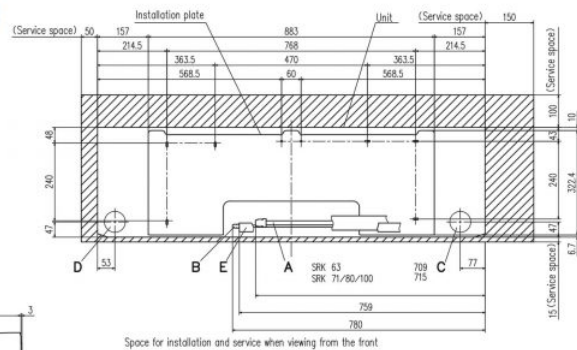
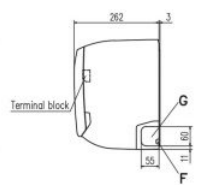
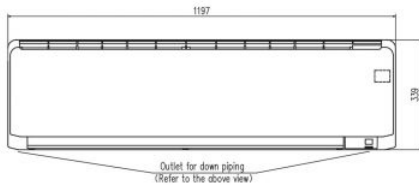
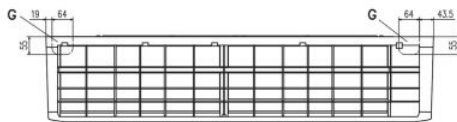

Space for installation and service when viewing from the front.

Symbol	Content
A	Gas piping SRK 63 $\phi 12.7$ (1/2") (Flare) SRK 71,80,100 $\phi 15.88$ (5/8") (Flare)
B	Liquid piping SRK 63,71,80 $\phi 6.35$ (1/4") (Flare) SRK 100 $\phi 9.52$ (3/8") (Flare)
C	Hole on wall for right rear piping ($\phi 65$)
D	Hole on wall for left rear piping ($\phi 65$)
E	Drain hose $\phi 16$
F	Outlet for wiring (on both side)
G	Outlet for piping (on both side)

Datorită politicii de continuă îmbunătățire a produselor, ne rezervăm dreptul de a modifica specificațiile tehnice fără nicio notificare prealabilă.